

YAMAHA AVX-500 *RS*

Natural Sound Stereo Amplifier
Active Servo Processing Speakers Drive Capability
7 Audio Inputs, 3 Video Inputs
S Video Input/Output Connectors
Dolby Pro Logic Surround-Sound System
Programmable Remote Control Transmitter

Thank you for selecting the YAMAHA model AVX-500 Stereo Amplifier.

CENTER

CONTENTS

Safety Instructions	2
Caution	3
Supplied Accessories	6
The Active Servo Technology	7
Connection of the Active Servo Processing Cartridge	7
Front Panel Components and Their Functions	8
Connections	10
Using the Surround-sound Processor	12
Operations	14
Remote-control Transmitter	16
Troubleshooting	24
Specifications	25

OWNER'S MANUAL



IMPORTANT!

Please make a note of the serial number of this unit in the space indicated below.

Model: **AVX-500**
Serial No.:

The serial number is inscribed on the rear of the unit. Keep this Owner's Manual in a safe place for future reference.

SAFETY INSTRUCTIONS



- Explanation of Graphical Symbols



The lightning flash with arrowhead symbol, within an equilateral triangle, is intended to alert you to the presence of uninsulated "dangerous voltage" within the product's enclosure that may be of sufficient magnitude to constitute a risk of electric shock to persons.



The exclamation point within an equilateral triangle is intended to alert you to the presence of important operating and maintenance (servicing) instructions in the literature accompanying the appliance.

WARNING

To reduce the risk of fire or electric shock, do not expose this appliance to rain or moisture.

- 1** Read Instructions – All the safety and operating instructions should be read before the appliance is operated.
- 2** Retain Instructions – The safety and operating instructions should be retained for future reference.
- 3** Heed Warnings – All warnings on the appliance and in the operating instructions should be adhered to.
- 4** Follow Instructions – All operating and other instructions should be followed.
- 5** Water and Moisture – The appliance should not be used near water – for example, near a bathtub, washbowl, kitchen sink, laundry tub, in a wet basement, or near a swimming pool, etc.
- 6** Carts and Stands – The appliance should be used only with a cart or stand that is recommended by the manufacturer.
- 6A** An appliance and cart combination should be moved with care. Quick stops, excessive force, and uneven surfaces may cause the appliance and cart combination to overturn.
- 7** Wall or Ceiling Mounting – The appliance should be mounted to a wall or ceiling only as recommended by the manufacturer.



- 8** Ventilation – The appliance should be situated so that its location or position does not interfere with its proper ventilation. For example, the appliance should not be situated on a bed, sofa, rug, or similar surface that may block the ventilation openings; or placed in a built-in installation, such as a bookcase or cabinet that may impede the flow of air through the ventilation openings.
- 9** Heat – The appliance should be situated away from heat sources such as radiators, stoves, or other appliances that produce heat.
- 10** Power Sources – The appliance should be connected to a power supply only of the type described in the operating instructions or as marked on the appliance.
- 11** Power-Cord Protection – Power-supply cords should be routed so that they are not likely to be walked on or pinched by items placed upon or against them, paying particular attention to cords at plugs, convenience receptacles, and the point where they exit from the appliance.
- 12** Cleaning – The appliance should be cleaned only as recommended by the manufacturer.
- 13** Nonuse Periods – The power cord of the appliance should be unplugged from the outlet when left unused for a long period of time.
- 14** Object and Liquid Entry – Care should be taken so that objects do not fall into and liquids are not spilled into the inside of the appliance.

CAUTION: READ THIS BEFORE OPERATING YOUR UNIT

15 Damage Requiring Service – The appliance should be serviced by qualified service personnel when:

- A.** The power-supply cord or the plug has been damaged; or
- B.** Objects have fallen, or liquid has been spilled into the appliance; or
- C.** The appliance has been exposed to rain; or
- D.** The appliance does not appear to operate normally or exhibits a marked change in performance; or
- E.** The appliance has been dropped, or the cabinet damaged.

16 Servicing – The user should not attempt to service the appliance beyond those means described in the operating instructions. All other servicing should be referred to qualified service personnel.

17 Power Lines – An outdoor antenna should be located away from power lines.

18 Grounding or Polarization – The precautions that should be taken so that the grounding or polarization is not defeated.

1 To ensure the finest performance, please read this manual carefully. Keep it in a safe place for future reference.

2 Install your unit in a cool, dry, clean place – away from windows, heat sources, and too much vibration, dust, moisture or cold. Avoid sources of hum (transformers, motors). To prevent fire or electrical shock, do not expose to rain and water.

3 Do not operate the amplifier upside-down. It may overheat, possibly causing damage.

4 Never open the cabinet. If a foreign object drops into the set, contact your dealer.

5 Do not use force on switches, knobs or cords. When moving the set, first turn the unit off. Then gently disconnect the power plug and the cords connecting to other equipment. Never pull the cord itself.

6 Do not attempt to clean the unit with chemical solvents; this might damage the finish. Use a clean, dry cloth.

7 Always set the volume control to “∞” while lowering the tonearm to play a record; turn the volume up with the stylus in the groove.

8 Be sure to read the “Troubleshooting” section on common operating errors before concluding that your unit is faulty.

9 Do not connect audio equipment to the AC outlets on the rear panel if that equipment requires more power than the outlets are rated to provide.

1 FRONT PANEL

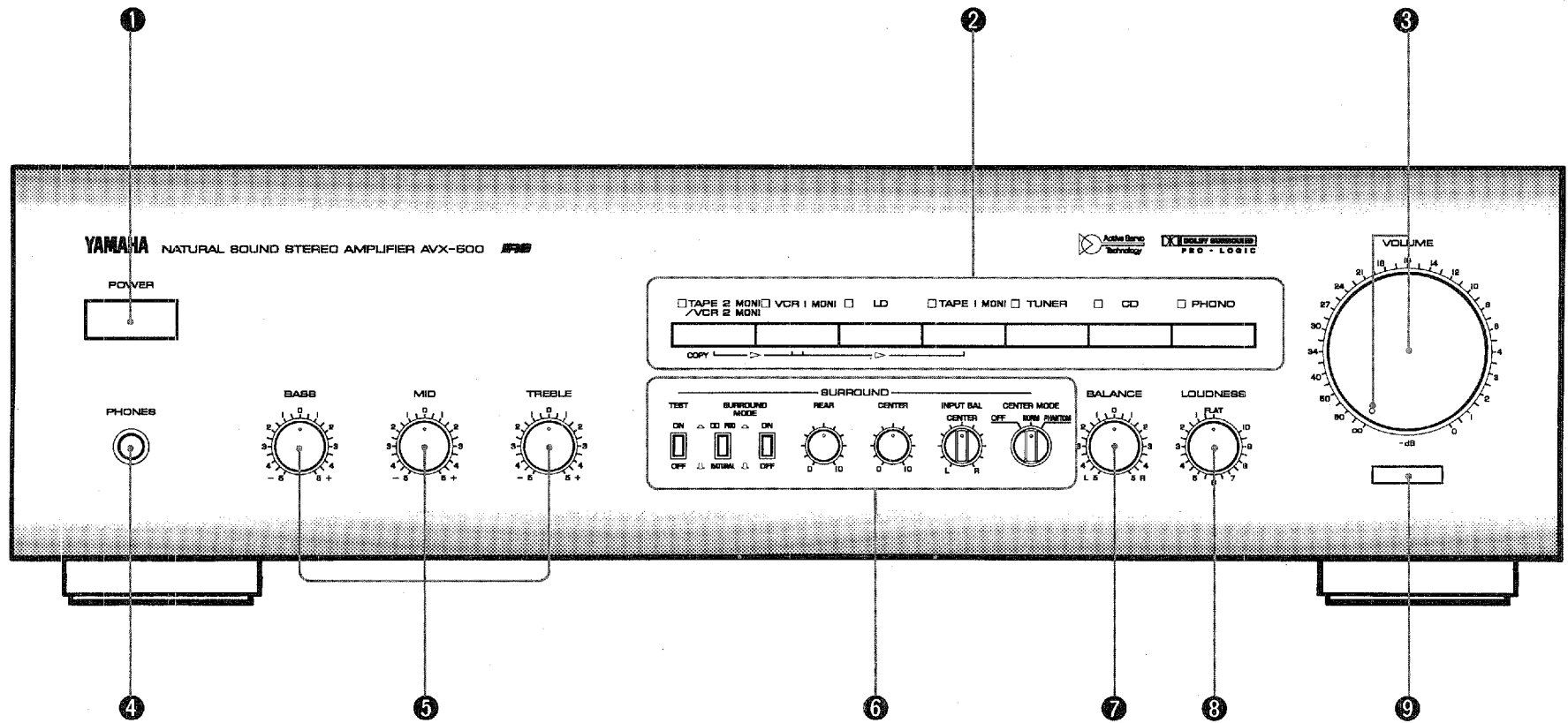

2 CONNECTIONS

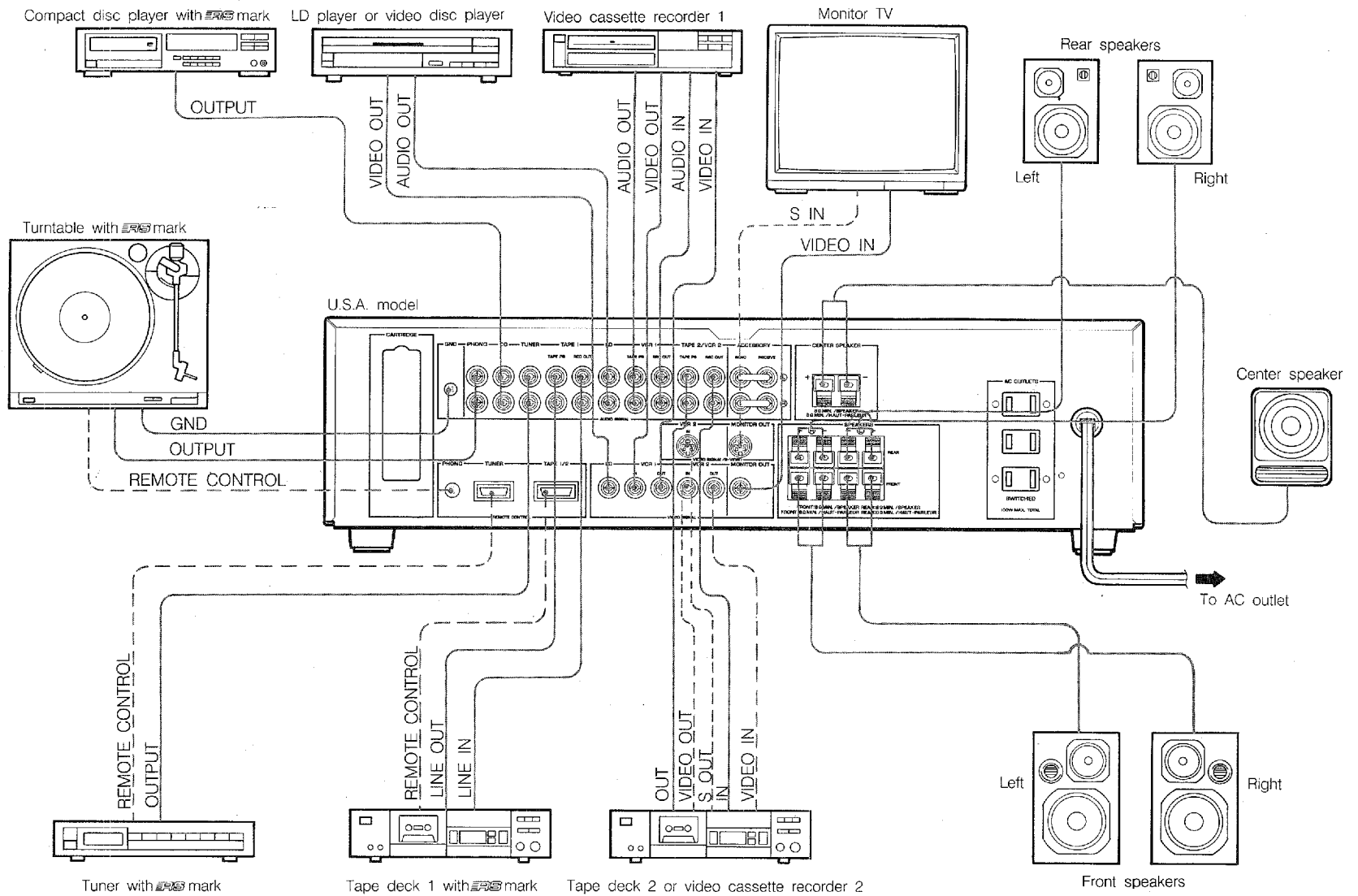

SUPPLIED ACCESSORIES

● After unpacking, check that the following parts are contained.

● Remote Control Transmitter

● Batteries

(U.S.A. and Canada models)

(Australia, Europe, U.K. and General Models)

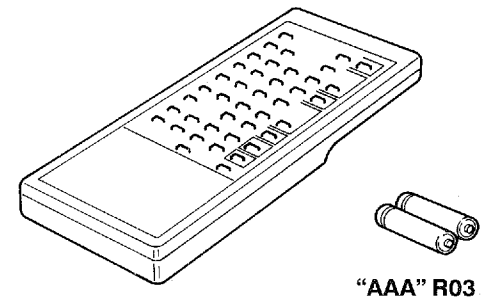
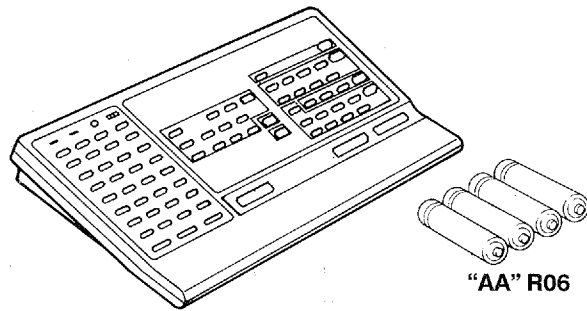

● Remote Control Cable (mini-plug, turntable)

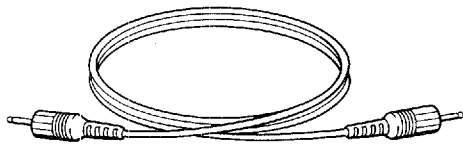

● Remote Control Cable (6-pin, cassette deck)

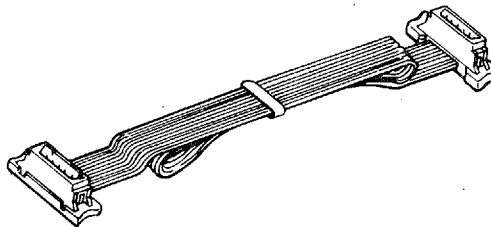

● Remote Control Cable (5-pin, tuner)

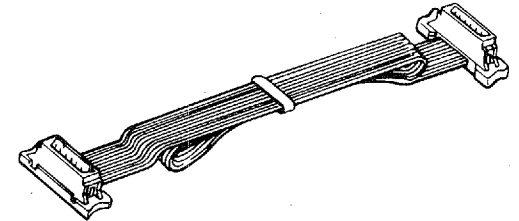

THE ACTIVE SERVO TECHNOLOGY

The theory of the Active Servo Technology is based upon two major factors, the Helmholtz resonator and negative-impedance drive. Active Servo Processing speakers reproduce the bass frequencies through an "air woofer", which is a small port or opening in the speaker's cabinet. This opening is used instead of, and performs the functions of, a woofer in a conventionally designed speaker system. Thus, signals of low amplitude within the cabinet can, according to the Helmholtz resonance theory, be output from this opening as waves of great amplitude if the design is such that the size of the opening and the volume of the cabinet are in the correct proportion to satisfy a certain ratio. In order to accomplish this, moreover, the amplitudes within the cabinet must be both precise and of sufficient power because these amplitudes must overcome the "load" presented by the air that exists within the cabinet.

Thus it is that this problem is resolved through the employment of a design in which the amplifier functions to supply the signals. If the electrical resistance of the voice coil is reduced to zero, the movement of the speaker unit would become linear with respect to signal voltage, and, to accomplish this, a special negative-impedance output-drive amplifier for subtracting output impedance of the amplifier is used.

By employing negative-impedance drive circuits, the amplifier is able to generate precise, low-amplitude low-frequency waves with superior damping characteristics, and these waves are then radiated from the cabinet opening as high-amplitude signals. The system can, therefore, by employing the negative-impedance output drive amplifier and a speaker cabinet with the Helmholtz resonator, reproduce an extremely wide range of frequencies with amazing sound quality and less distortion.

The features described above, then, are combined to be the fundamental structure of the Active Servo Technology.

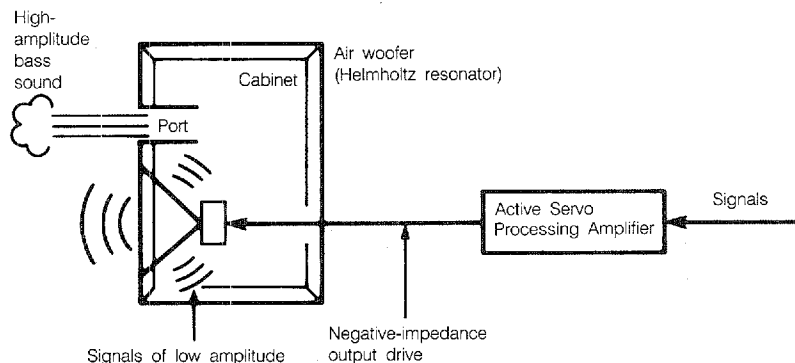

CONNECTION OF THE ACTIVE SERVO PROCESSING CARTRIDGE

For negative-impedance drive of Active Servo Processing speaker systems by this unit, the Active Servo Processing cartridge that is included with Active Servo Processing speaker systems (and which is designed especially for those speaker systems) must be inserted into the cartridge holder located on the rear panel of this unit.

As shown in the figure below, insert the cartridge so that the connector end of the cartridge enters the cartridge holder.

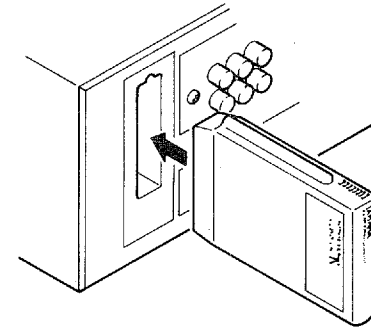

NOTE

- When the Active Servo Processing cartridge is not connected to this unit, this unit can be used to drive only conventional speakers. Never attempt to use this unit to drive conventional speakers while the Active Servo Processing cartridge is inserted in this unit, because to do so may cause damage to this unit and/or the speakers.
- Be absolutely sure that this unit's power is OFF before connecting or disconnecting the cartridge to or from this unit.
- Use Active Servo Processing speakers only as front speakers. So, be sure to connect them to the FRONT SPEAKERS terminals on the rear panel of this unit.

FRONT PANEL COMPONENTS AND THEIR FUNCTIONS

(See Fig. 1.)

① POWER switch

Press this switch to turn the power on. Press the switch again to turn the power off.

STANDBY indicator (models for Europe only)

While the power of the unit is ON, you can switch the unit to the STANDBY mode by pressing the POWER key on the remote-control transmitter. In this mode, only the STANDBY indicator will illuminate; other indicators will not. To switch the power ON again, press the POWER key on the remote-control transmitter once again. To switch the power OFF completely, however, the POWER switch on the main unit should be pressed.

② Input selectors and indicators

These selectors are used to select the audio or video source to listen to or watch.

LD, TUNER, CD, PHONO

Use these to select either a LD player (or video disc player) (by pressing "LD"), a tuner ("TUNER"), a compact-disc player ("CD"), or a turntable ("PHONO"). The corresponding indicator will illuminate. Note that only one of these four sources can be selected at a time.

TAPE 1 MONI, VCR 1 MONI, TAPE 2 MONI/VCR 2 MONI

These selectors are also used to select an audio tape deck or a VCR as input source. In addition, these can be used to monitor the audio or (and) video signals to be recorded to an audio tape deck or a VCR during recording. Use these to select either the first audio tape deck (by pressing "TAPE 1 MONI"), the first VCR ("VCR 1 MONI") or the second audio tape deck (or the second VCR) ("TAPE 2 MONI/VCR 2 MONI"). The corresponding indicator will illuminate. Pressing these selectors once again will cancel their activation and the corresponding indicator's illumination will stop.

Note

If two or more of these selectors are pressed at the same time, the order of priority for their function is as follows:

1) TAPE 1 MONI, 2) VCR 1 MONI, 3) TAPE 2 MONI/VCR 2 MONI.

When the TAPE 1 MONI function is activated, therefore, the audio tape deck's audio signals will be heard regardless of which selector is activated. However, the video signals of another source can not be interrupted by the TAPE 1 MONI's activation.

NOTE

If a monitoring type input selector and some other input selectors are pressed at the same time, each of the corresponding indicators will illuminate, but only the monitoring type input selector will function; the other selector will not function.

③ VOLUME control and power indicator

This control is used to adjust the output volume level. Turning the control clockwise increases the sound level and turning it counterclockwise decreases the sound level. It acts as the master volume control: increasing or decreasing the signal level to the front, rear speaker pairs and the center speaker. The built-in indicator lights when the POWER switch is set to ON.

④ PHONES jack

This jack is used to privately listen to the sound. Insert your headphone plug into it. The sound from the speakers will not be heard.

⑤ Tone controls

BASS control

This control is used to increase or decrease the low frequency response. The "0" center click position produces a flat response. Rotating the control in the + direction increases the low frequency response. Conversely, rotating the control in the - direction decreases it.

MID control

This control is used to increase or decrease the mid-range frequency response. The "0" center click position produces a flat response. Rotating the control in the + direction increases the mid-range frequency response. Conversely, rotating the control to the - direction decreases it.

TREBLE control

This control is used to increase or decrease the high frequency response. The "0" center click position produces a flat response. Rotating the control in the + direction increases the high frequency response. Conversely, rotating the control in the - direction decreases it.

⑥ SURROUND processing mode controls

These controls are used to implement the following surround sound features:

TEST tone switch

This switch will function only when the SURROUND MODE ON/OFF switch is set to ON and the SURROUND MODE selector is set to the **PRO** position.

When this switch is in the ON (depressed) position, this unit generates a pink noise signal that is sent in succession to the right, center, left, and surround channels. This function is useful for adjusting the REAR level control and CENTER level control.

SURROUND MODE selector

Use this selector to set the surround mode according to the source played.

PRO DOLBY PRO LOGIC SURROUND

Set to this position when playing a program source having the " **PRO** DOLBY SURROUND" marking.

NATURAL SURROUND

Natural surround-sound effects can be reproduced from ordinary stereo sources, using YAMAHA's original surround-sound processor circuit.

* No sound is output from the rear speakers when the played source is monaural.

SURROUND MODE ON/OFF switch

Set this switch to ON to enable the surround mode features. Set this switch to OFF when listening to the normal 2-channel stereo sound without surround-sound effect. The rear speaker do not operate in the normal 2-channel stereo mode.

REAR level control

This control raise or lower the volume at REAR SPEAKERS terminals.

CENTER level control

This control adjusts center channel signal level. This has no effect in the "PHANTOM" mode.

Input balance control (INPUT BAL)

Use this control to obtain the best surround-sound condition. For details of the surround-sound condition adjustment, refer to page 13.

CENTER MODE selector

Set to the OFF position when adjusting the input balance control. Set to the NORMAL position to listen to the center channel information through the center speaker. Set to the PHANTOM position if you wish the center channel information to be reproduced through the conventional left and right channel front (main) speakers.

⑦ BALANCE control

Use this control to concurrently change the left and right output volume the speaker terminals to compensate for sound imbalance caused from speaker settings or listening room condition.

⑧ Continuous variable LOUDNESS control

This control can be used to retain full tonal range at any volume levels. The sensitivity of ears to high and low frequency ranges will be lost at low volume settings. However, this control provides an equalization curve based on human hearing.

To adjust the LOUDNESS control to your listening level, first, set the control to the FLAT position, turn the VOLUME control to your loudest listening level, then turn the LOUDNESS control counterclockwise to reduce the volume level without losing the natural tone.

⑨ REMOTE CONTROL sensor

This is used to receive signals from the remote control transmitter.

CONNECTIONS

(See Fig. 2.)

Notes on connections

- Before attempting to make any connections to or from this unit, be sure to first switch OFF the power to this unit and to any other components to which connections are being made.
- When making connections between this unit and other components, be sure all connections are made correctly, that is to say L (left) to L, R (right) to R, "+" to "+" and "-" to "-".

Power cord

Connect the power cord of this unit to an AC outlet.

Speakers

Connect the SPEAKERS terminals to your front and rear speakers with the proper gauge of wire, cut to be as short as possible. Press the speaker wire terminal tabs, then insert the bare wires and secure them by releasing the tabs. In the same way, connect the CENTER SPEAKER terminals to your center speaker. If these connections are faulty, no sound will be heard from the speakers. Make sure that the polarity of the speaker wires is correct, that is, that the + and - markings are observed. If these wires are reversed, the sound will be unnatural and will lack bass. Do not coil up excess speaker wire or bundle the speaker cables with the power cords.

Turntable

Connect the output cords of the turntable to the PHONO jacks, and connect the ground cord to the GND terminal. This should produce minimum hum, but in some cases better results are obtained with this cord disconnected.

Compact disc player

Connect the output jacks of the compact disc player to the CD jacks.

LD/Video disc player

Connect the video output jack from a LD player or a video disc player to the LD (VIDEO SIGNAL) jack.

Connect the audio output jacks from a LD player or a video disc player to the LD (AUDIO SIGNAL) jacks.

Tuner

Connect the output jacks of the tuner to the TUNER jacks.

Tape deck

Connect the cable from an audio tape deck or other audio tape unit to the TAPE 1 jacks. The playback (LINE OUT) jacks of the audio tape deck go to the TAPE PB jacks, and the record (LINE IN) jacks go to the REC OUT jacks on the rear panel of this unit.

In the same way, your second audio tape deck also can be connected to the TAPE 2/VCR 2 jacks on the rear panel of this unit.

VCR (Video cassette recorder)

Connect the video jacks of the VCR to the VCR 1 (VIDEO SIGNAL) jacks on the rear panel of this unit. The video playback (VIDEO OUT) jack of the VCR goes to the IN jack, and the video record (VIDEO IN) jack goes to the OUT jack.

Connect the audio output jacks of the VCR to the VCR 1 (AUDIO SIGNAL) jacks. The audio playback (AUDIO LINE OUT) jacks of the VCR go to the TAPE PB jacks, and the audio record (AUDIO LINE IN) jacks go to the REC OUT jacks.

In the same way, your second VCR also can be connected to the TAPE 2/VCR 2 (AUDIO SIGNAL) jacks and VCR 2 (VIDEO SIGNAL) jacks on the rear panel of this unit.

NOTE

Connect either the second audio tape deck or the second VCR to the TAPE 2/VCR 2 jacks.

Monitor TV

Connect the video jack from a monitor to the MONITOR OUT jack. Note that the audio connections to the monitor are not necessary as the audio portion of the signal is sent to your speakers through this unit.

VCR and Monitor TV with S connectors

(U.S.A., Canada, Australia and General models only)

When a VCR that has S connectors is used as the second VCR, connect it to the VIDEO SIGNAL/S-VIDEO connectors of this unit. With the S-VIDEO connections, a high resolution picture will be obtained, resulting in a much clearer reproduction.

Connect the S output connector of the VCR to the VIDEO SIGNAL/S-VIDEO IN connector on the rear panel of this unit.

When a monitor that has an S video connector is used, connect it to the S-VIDEO MONITOR OUT connector of this unit.

Note

If signals from the VCR are not input to this unit through the S connector, there is no signal output at the S VIDEO MONITOR OUT connector. Because the VIDEO SIGNAL IN and OUT jacks and the S-VIDEO IN connector have separate built-in circuits, there must be a connection to the S-VIDEO IN connector when signals are to be output to the S-VIDEO MONITOR OUT connector.

In addition, the circuits for the VIDEO SIGNAL IN and OUT jacks and the S-VIDEO IN connector are linked when "VCR 2" is selected as the source by using the input selector.

When the VCR is connected to both the VIDEO SIGNAL IN jack and the S-VIDEO IN connector, signals will be output to both S-VIDEO MONITOR OUT and VIDEO SIGNAL MONITOR OUT, so select (at the monitor) which signal is to be monitored.

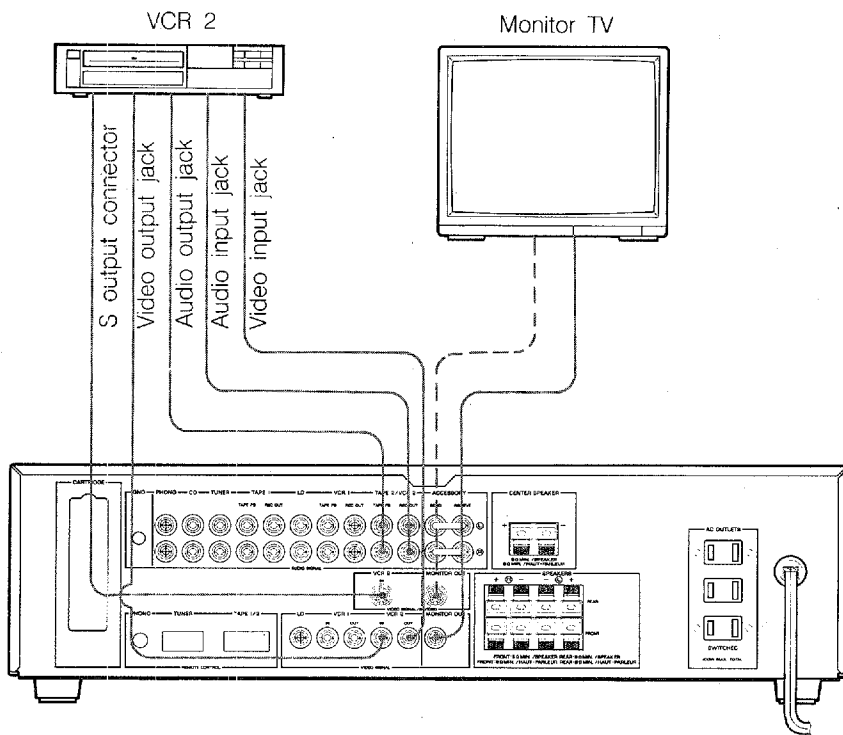

OTHER REAR PANEL CONNECTIONS

ACCESSORY (SEND/RECEIVE) jacks

For extra system flexibility, this unit allows you to connect a signal processing system, such as a graphic equalizer or other equipments. To connect these units, pull out the jumper pins from the ACCESSORY (SEND/RECEIVE) jacks, connect the inputs of the unit to the RECEIVE jacks and outputs to the SEND jacks.

REMOTE CONTROL CONNECTORS

These connectors are used when you have YAMAHA components (with the *RS* mark).

These connections allow you to control the components from the provide remote control transmitter.

PHONO

Connect to a turntable using the cable with miniplug connectors.

TUNER

Connect to a tuner using the cable with 5-pin connectors.

TAPE

Connect to a cassette tape deck using the cable with 6-pin connectors.

- Note that no cable is necessary for a compatible CD player, a compatible cassette deck, a compatible tuner, etc. which has a remote control sensor because the remote control transmitter operates them directly.

AC OUTLETS

(U.S.A., Canada, General and Europe models)

.....3 SWITCHED OUTLETS
(Australia and U.K. models)1 SWITCHED OUTLET

Use these to connect the power cords from your components to this unit. The power to the SWITCHED outlets is controlled by this unit's POWER switch or remote control transmitter's POWER key. They will supply power to any component whenever this unit is turned on. The total maximum power that can be connected to the SWITCHED outlets is 100 watts.

USING THE SURROUND-SOUND PROCESSOR

This unit incorporates a sophisticated surround-sound processing circuitry which allows you to expand the audio sound field for a theater-like experience in the listening/viewing room.

SPEAKER PLACEMENT

In a full 5-channel system you will use two pairs of speakers: the FRONT SPEAKERS, the REAR SPEAKERS, and the CENTER SPEAKER. You will probably use your present stereo speaker system for the FRONT SPEAKER pair. The rear and center speakers do not need to be of such high quality. But they should have high enough power handling to accept the maximum output of this unit that will drive them.

FRONT SPEAKERS

Place the FRONT SPEAKERS in the normal position.

REAR SPEAKERS

Place the REAR SPEAKERS beside your listening position and facing a little inward. They should be nearly six feet up from the floor.

CENTER SPEAKER

Place the CENTER SPEAKER precisely between the two FRONT SPEAKERS. (To avoid interference, use a magnetically shielded speaker. If, however, it is not effective, keep the speaker away from TV sets.)

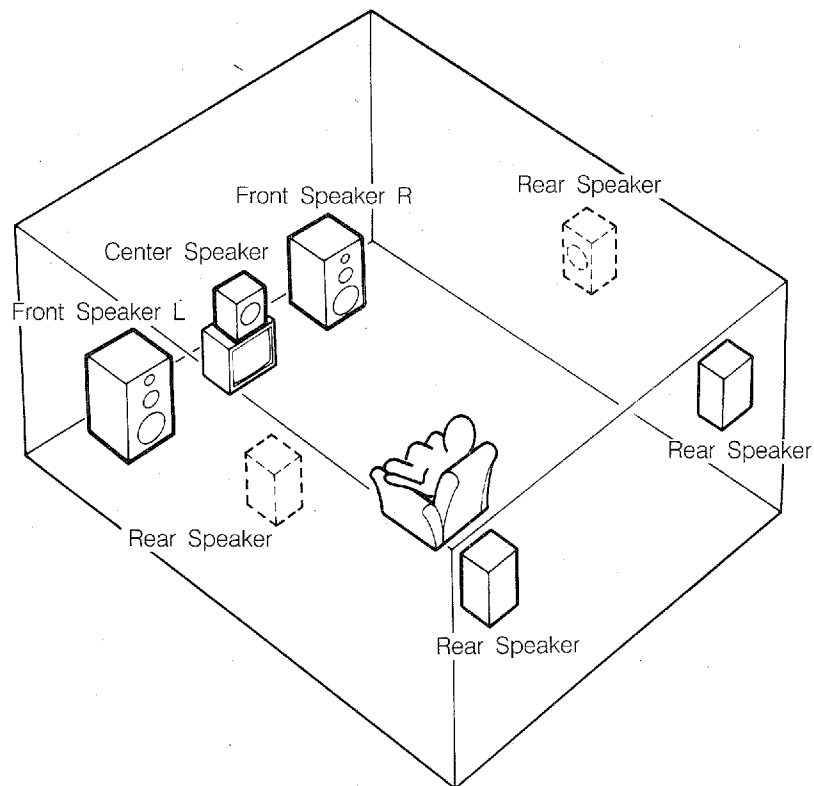

SURROUND MODES

DOLBY PRO LOGIC SURROUND

This unit employs the Dolby Pro Logic Surround Sound system. This system is similar to professional Dolby stereo decoders used in movie theaters, and the effect is more realistic than the conventional Dolby Surround Sound Processing System for home use.

The Dolby Pro Logic Surround Sound system, by employing a four-channel system, divides the input signals into four levels: the left and right main channels, the center channel (to characterize dialogue), and the rear surround-sound channels (to characterize sound effects, background noise and other ambient noise).

As a result, compared to the conventional 3-channel surround-sound system, the yield of the true center channel is added, thus even further expanding the width of the surround-sound effect.

Dolby surround-sound is encoded on the sound track of commercially available video cassettes and video discs as well. When you play a source encoded with Dolby surround-sound on your home video system, the Dolby Pro Logic surround mode on this unit decodes the signal and feeds the surround-sound effects.

The Dolby Pro Logic surround mode will have no effect on video sources not encoded with Dolby surround-sound.

Note

If a graphic equalizer is connected to this unit, be sure all equalizer's controls are set to the flat position when this unit is in the Dolby Pro Logic surround mode. Otherwise, Dolby Pro Logic playback will not be reproduced accurately.

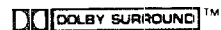

Manufactured under license from Dolby Laboratories Licensing Corporation. Additionally licensed under one or more of the following patents: U.S. numbers 3,632,886, 3,746,792, and 3,959,590; Canada numbers 1,004,603 and 1,037,877. "Dolby" and the double-D symbol are trademarks of Dolby Laboratories Licensing Corporation.

NATURAL SURROUND

The Natural Surround is an exclusive YAMAHA surround-sound processing mode which is effective with all music and audio sources of video sound. It creates a natural, lifelike surround-sound effect without the use of delay circuitry, adding considerable depth and imaging to all audio sources. It is recommended for both music listening and for viewing stereo video sources.

Note

If a monaural sound source is used in the Dolby Pro Logic or Natural Surround mode, no sound will be heard from the rear speakers.

INPUT BALANCE CONTROL ADJUSTMENT

To obtain the best surround-sound condition, be sure to adjust the INPUT BAL control.

1. Disconnect the speaker wires from the front speakers (so that the sound from the front speakers will not be heard).
2. Set the front panel controls as follows.
 - Set the CENTER MODE selector to the "OFF" position.
 - SURROUND MODE ON/OFF switch – Set to ON.
 - SURROUND MODE selector – Set to the  PRO position.
 - REAR level control – Set to the "10" (maximum) position.
3. Set the INPUT BAL control to the center position.
4. Play the monaural portion (such as dialogue) of a program source encoded with Dolby surround-sound.
5. Increase the VOLUME control setting so that you can hear the monaural program source through the rear speakers.
6. Then minimize the rear speakers' output by slightly turning the INPUT BAL control clockwise or counterclockwise until you achieve a "null" (i.e. minimum output from your rear speakers).
NOTE: As you approach the "null", increase the VOLUME control setting to better hear your rear speakers.

With this adjustment, the best surround-sound balance can be obtained.

FRONT/CENTER/REAR SPEAKER BALANCE ADJUSTMENT

Using the built-in test tone generator, this procedure lets you adjust the volume balance between the front, center, and rear speakers. This adjustment is important for proper Dolby Pro Logic Surround-sound operation.

1. Set the SURROUND MODE ON/OFF switch to ON.
 2. Set the SURROUND MODE selector to the " **DD** PRO" position.
 3. Set the CENTER MODE selector to the NORM position.
 4. Turn on the TEST tone switch.
 5. Turn up the VOLUME control. You will hear a test tone (pink noise) from the right front speaker, then the center speaker, then the left front speaker, then the rear speakers, for about two seconds each.
 6. Adjust the REAR level and CENTER level controls so that the volume heard at the listening position is the same from each speaker.
- If not using a center speaker, be sure to set the front panel CENTER MODE selector to the PHANTOM position. You will then hear the center channel test tone from the left and right front speakers.

After completing this adjustment, turn off the front panel TEST switch.

OPERATION

1. Set the SURROUND MODE ON/OFF switch to ON.
2. Select the surround mode with the SURROUND MODE selector.
3. Play the program source.
4. Use the VOLUME control to adjust the whole sound level.

TO PLAY A PROGRAM SOURCE

1. Set the VOLUME control to minimum.
2. Press the POWER switch to switch the power ON.
3. For video sources, turn the TV/monitor ON.
4. Select the program source to be listened to or watched with the input selector. When selecting LD, TUNER, CD or PHONO, be sure that TAPE 1 MONI, VCR 1 MONI and TAPE 2 MONI/VCR 2 MONI are not being pressed.
5. Play the program source.
6. Adjust the VOLUME control.

Note

- If both LD and TAPE 1 MONI are selected, the LD video signals will be output to the MONITOR OUT jack.
- If a LD player (or video disc player) is playing, its video signals are being output to the MONITOR OUT jack regardless of which input selector (except VCR 1 MONI and TAPE 2 MONI/VCR 2 MONI) is pressed.

For details of the surround mode, refer to "USING THE SURROUND-SOUND PROCESSOR".

TO RECORD A PROGRAM SOURCE TO AUDIO/VIDEO TAPE

1. Set the VOLUME control to minimum.
2. Press the POWER switch to switch the power ON.
3. Select the program source to be recorded with the input selector. When selecting LD, TUNER, CD or PHONO, be sure that TAPE 1 MONI, VCR 1 MONI and TAPE 2 MONI/VCR 2 MONI are not being pressed.
4. Play the program source to be recorded and set the tape deck or VCR used for recording to the RECORD mode.
5. By pressing the input selector for tape deck or VCR used for recording, you can monitor the audio or (and) video signals to be recorded.

The settings of the SURROUND processing mode controls, the VOLUME control, the tone controls, etc. do not affect the recording.

TO DUB FROM ONE AUDIO TAPE DECK OR VCR TO ANOTHER

By using the input selectors for audio tape decks or VCRs, three ways of dubbing (①, ② and ③ in the following diagrams) can be performed.

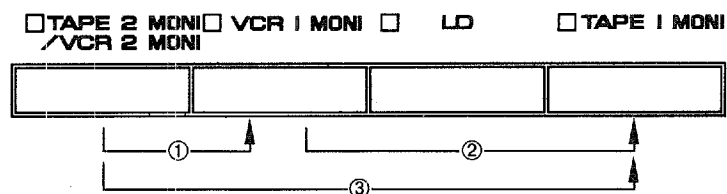

	Input selector for the signal sending unit	→	Input selector for the signal receiving unit
①	TAPE 2 MONI/VCR 2 MONI	→	VCR 1 MONI
②	VCR 1 MONI	→	TAPE 1 MONI
③	TAPE 2 MONI/VCR 2 MONI	→	TAPE 1 MONI

*Note that each dubbing will succeed only in the direction shown above.

1. Set the VOLUME control to minimum.
2. Press the POWER switch to switch the power ON.
3. Press the input selector for the audio tape deck or VCR sending the signals (the playback tape deck or VCR).
Be sure that the selector for another audio tape deck or VCR are not being pressed.
4. Set the tape deck or VCR sending the signals to the PLAY mode and the tape deck or VCR receiving the signals to the RECORD mode.
You can monitor the audio or (and) video signals to be recorded, by pressing the selector for the tape deck or VCR receiving the signals (the recording tape deck or VCR).

Note

- When dubbing is performed from a VCR to an audio tape deck, only audio signals of the VCR will be dubbed to the audio tape deck.
- The settings of the SURROUND processing mode controls, the VOLUME control, the tone controls, etc. do not affect the dubbing.

INPUT SOURCES ORDER OF PRIORITY

When selecting two or more program sources at the same time (by using input selectors), be sure to remember the order of priority of the input sources.

Audio sources order of priority: 1) TAPE 1 MONI, 2) VCR 1 MONI, 3) TAPE 2 MONI/VCR 2 MONI, and 4) LD, TUNER, CD or PHONO.

Video sources order of priority: 1) VCR 1 MONI, 2) TAPE 2 MONI/VCR 2 MONI and 3) LD.

REMOTE-CONTROL TRANSMITTER

■ CONTROLS AND THEIR FUNCTIONS

(U.S.A. AND CANADA MODELS)

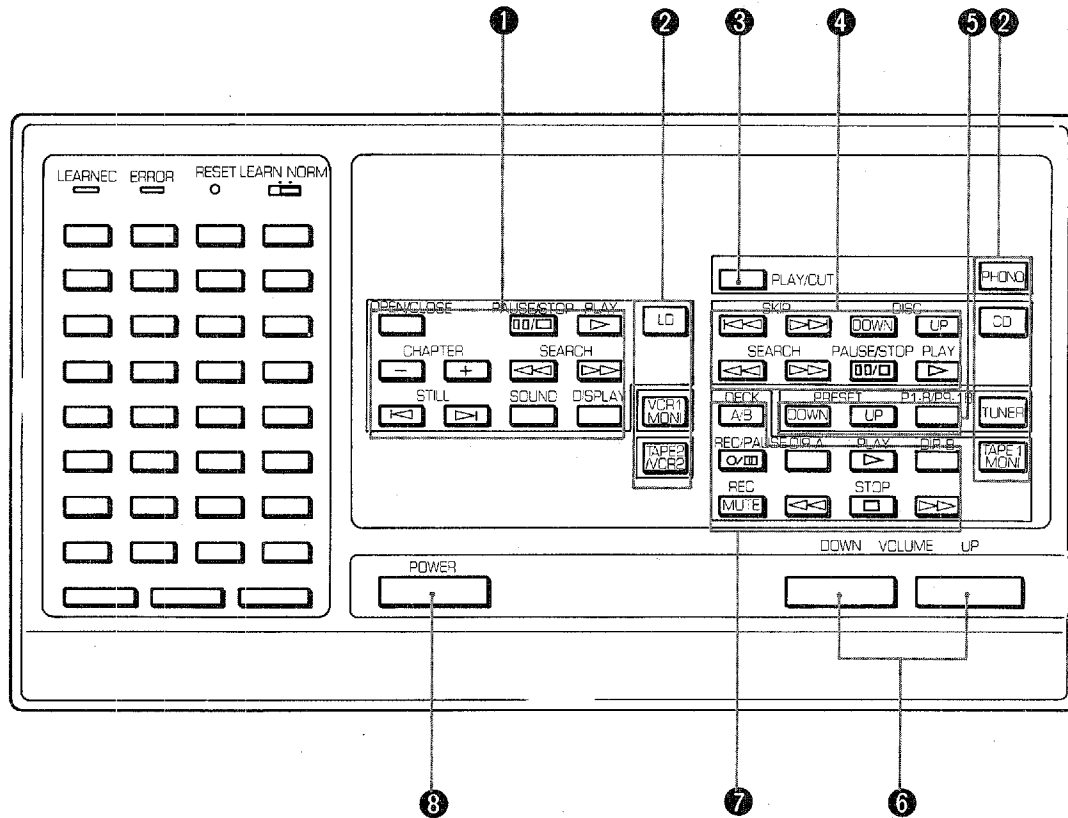

(EUROPE, U.K., AUSTRALIA AND GENERAL MODELS)

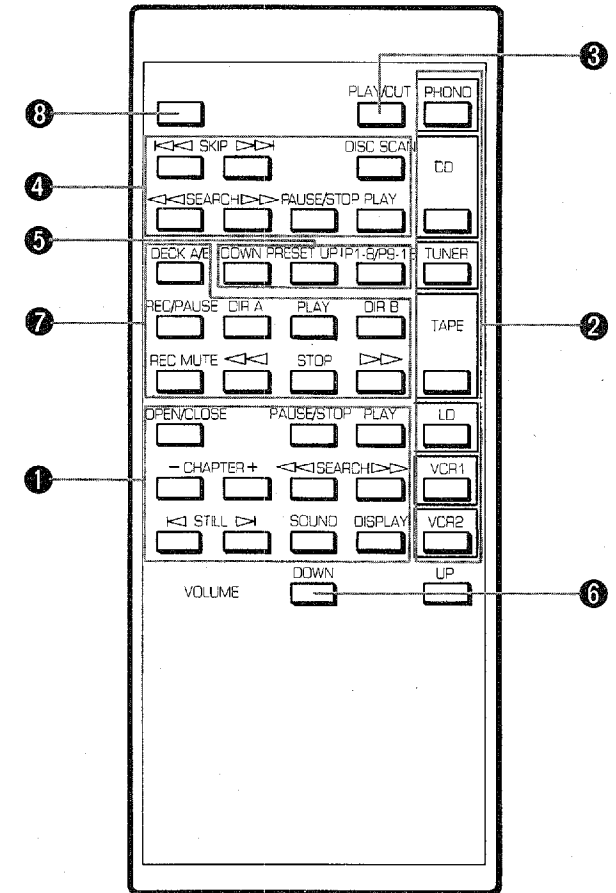

The remote-control transmitter provided with this unit is designed to control all the most commonly used functions of the amplifier. If the CD player, LD player, turntable, tuner and cassette deck connected to this unit are YAMAHA components designed for remote control compatibility (components with an  mark), then this remote-control transmitter will also control various functions of each component. Please consult YAMAHA dealer for information on which components are compatible with the remote-control transmitter. Note that any compatible YAMAHA CD player, tuner, LD player or a compatible YAMAHA cassette deck with a remote control sensor, can be directly operated by this remote-control transmitter.

① LD player keys

A YAMAHA LD player (such as CDV-1600 or other models) that bears the  mark can, when connected to this unit, be directly controlled by using this remote-control transmitter.

OPEN/CLOSE key

Press this key to open or close the disc tray.

PAUSE/STOP key

Press this key once to temporarily stop the LD player operation; when it is pressed again, the LD player changes to the stop mode.



PLAY key

Press this key to start the disc play.



CHAPTER keys (LD)

- + When this key is pressed during LD play, the beginning of the next "chapter" is detected.
- When this key is pressed during LD play, the beginning of the "chapter" now playing is detected.

SEARCH keys

-  When this key is pressed during play, play is advanced at high speed.
-  When this key is pressed during play, play is reversed at high speed.

STILL keys (CAV)

-  When this key is pressed during LD (CAV) play, a still picture or frame-by-frame pictures can be displayed in the forward direction.
-  When this key is pressed during LD (CAV) play, a still picture or frame-by-frame pictures can be displayed in the reverse direction.

SOUND select key (LD)

This key can be used to select the sound to be played from the disc and which will be output from the left and right audio signal output jacks. The selected audio signal changes in the order: STEREO → 1/L-CH → 2/R-CH each time the key is pressed.

DISPLAY key

When this key is pressed during the play of a LD (CAV), the "chapter" and frame numbers of the picture now being viewed are displayed on the screen.

When this key is pressed during the play of a LD (CLV), the "chapter" number and the time are displayed on the screen.

When this key is pressed during the play of a compact disc, the total time, the remaining time or the track time is displayed on the screen.

② Input selector keys

These keys are used to select the audio or the video source.

③ PLAY/CUT key

This key can be used to start or stop disc play on the turntable (with the  mark) connected to this unit. This key functions in the same way as the PLAY/CUT key on the turntable itself. Press it once to start play, and once again to stop play.

④ Compact-disc player keys

A YAMAHA compact-disc player with the  mark can, when connected to this unit, be directly controlled by using this remote-control transmitter.

SKIP key

Press this key to advance to the beginning of the next track on the disc.

SKIP key

Press this key to return to the beginning of the track now playing.

If this key is pressed at the beginning of a track, play will begin from the beginning of the previous track.

SEARCH key

Press this key to advance rapidly.

SEARCH key

Press this key to reverse rapidly.

DISC UP/DOWN keys (U.S.A. and Canada models)

These keys are used for selection of the disc, and are applicable only to compact-disc players that have the magazine type of automatic disc-changing mechanism.

Note: If a carousel-type compact-disc player is used, the DISC DOWN key has no function (only the DISC UP key operates to select the next disc in the carousel).

DISC SCAN key (Europe, U.K., Australia and General models)

This key is used for selection of the disc, and is applicable only to compact-disc players that have an automatic disc-changing mechanism.

PAUSE/STOP key

This key is used to stop (or temporarily stop: pause) the compact-disc player operation.

Play stops temporarily when the key is pressed once, and changes to a complete stop when the key is pressed again.

PLAY key

Press this key to play the compact-disc.

5 Tuner keys

A tuner with the **RS** mark can be controlled by using this remote-control transmitter.

P1-8/P9-18 keys

This key is used to switch between the two banks of station presets.

PRESET UP and DOWN keys

These keys are used to switch to the next higher (UP) or the lower (DOWN) preset station.

6 VOLUME control keys

These keys are used to adjust the volume level from the speakers.

(U.S.A. and Canada models)

These keys also have the "learning" function. Refer to "ABOUT THE 'LEARNING' FUNCTION" on page 20 for details.

7 Cassette tape deck keys

A cassette tape deck with the **RS** mark can, when connected to this unit, be controlled by using this remote-control transmitter.

DECK A/B key

Press this key to select either deck A or deck B if the cassette deck connected is a double-cassette deck.

PLAY key

Press this key to start tape playback. If the deck connected is a double-cassette deck, the tape in the deck that played back most recently will begin playback when this key is pressed.

◀◀ and ▶▶ keys

Press these keys to advance the tape rapidly in the direction of the arrow.

REC/PAUSE key

Press this key to set the cassette tape deck to the recording-pause mode.

STOP key

Press this key to stop the tape movement.

REC MUTE key

Press this key to make a non-recorded space on the tape while a recording is in progress.

DIR A key

Press this key to change the moving direction of the tape. If a double-cassette deck is used, this key changes the moving direction of the tape in the deck A.

DIR B key (for use with a double-cassette deck only)

Press this key to change the moving direction of the tape in the deck B.

8 POWER key

Press this key to turn the power of this unit ON and OFF.

Europe model

This key functions only when the STANDBY indicator is lit.

■ BATTERY INSTALLATION/REPLACEMENT

- Install the batteries as shown below.

(U.S.A. and Canada models)

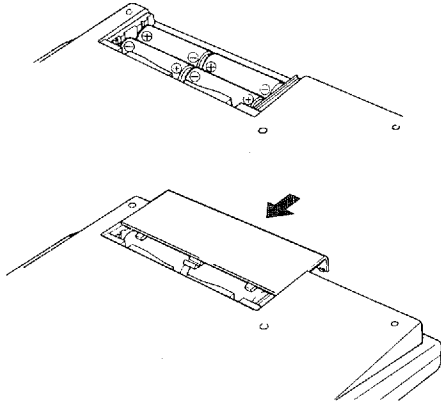

(Europe, U.K., Australia and General models)

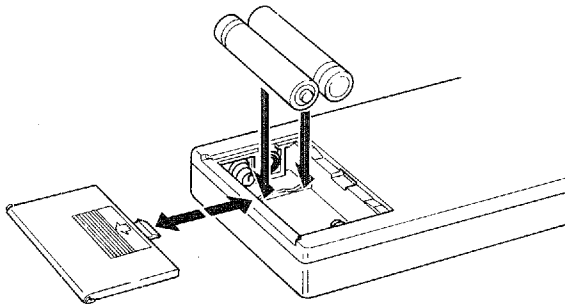

- Be sure to follow the diagram in the battery compartment to assure the proper positive (+) and negative (-) polarity.
- Do not use old and new batteries at the same time.
- If a battery leaks, dispose of all batteries; then clean the battery compartment thoroughly before installing new batteries.

■ OPERATION RANGE

The remote-control transmitter must be faced toward the component to be controlled, and be within a range of about 7 meters (23 feet) for proper operation.

(U.S.A. and Canada models)

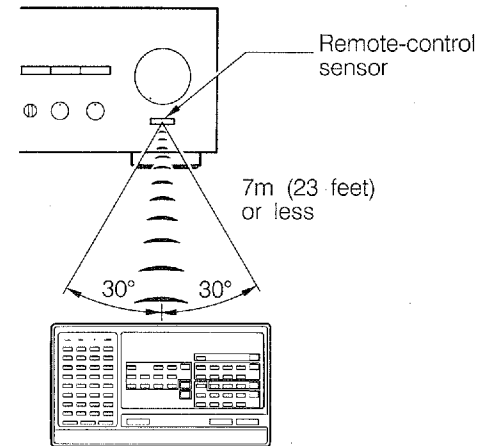

(Europe, U.K., Australia and General model)

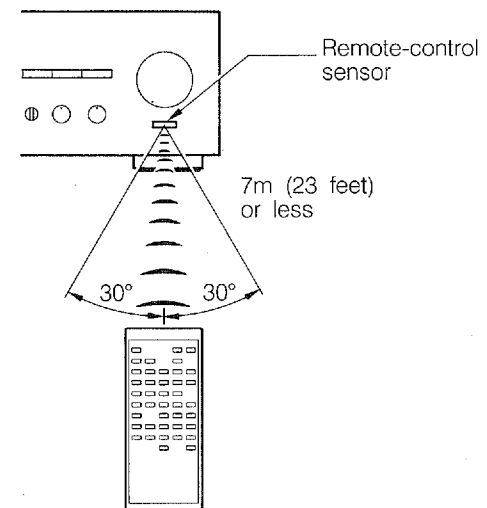

■ ABOUT THE "LEARNING" FUNCTION (applicable to U.S.A. and Canada models only)

This remote-control transmitter has a number of programmable keys. These keys can be programmed to "learn" the signal patterns from other remote-control transmitters.

By programming this unit with the signals from other remote-control transmitters, this unit can then be used in place of one or more other remote-control transmitters, thus making operation of your various audio and video components more convenient.

NOTE

There may occasionally be instances, due to the signal-coding and modulation systems employed by the other remote-control transmitter, that this unit will not be able to "learn" its signals.

IDENTIFICATION OF PARTS

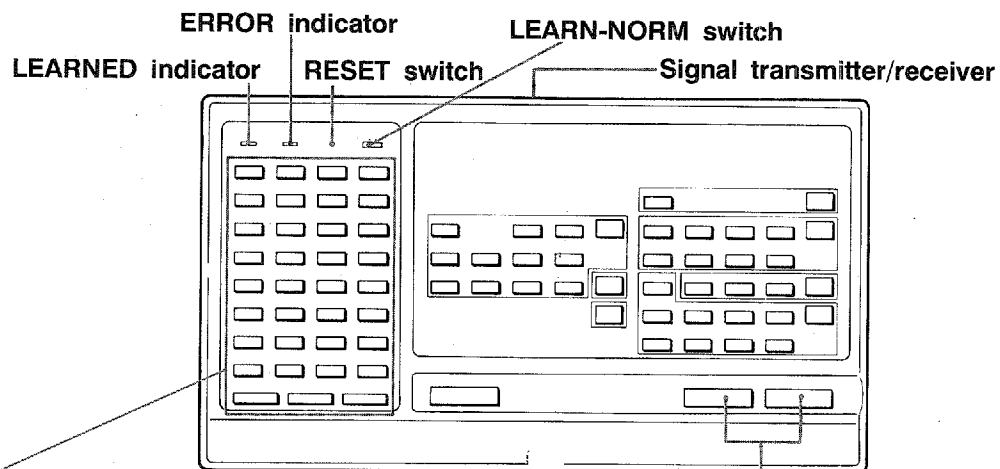

Learning keys

These keys can be used to "learn" (program) signals from other remote-control transmitters.

Programmable preset learning keys

These keys have already been preset with signals for controlling the sound volume, but, if desired, other signals can be "learned" by these keys (over the preset signals), in the same way as the ordinary learning keys.

(The "learning" method is the same as that for the ordinary learning keys.)

* These keys are convenient for programming signals for use as the master volume control of a YAMAHA digital-sound-field processor (model DSP-3000, DSP-100, DSR-100PRO, etc.) and so on.

TO PROGRAM SIGNALS FROM OTHER REMOTE-CONTROL TRANSMITTERS

Before programming

- Some learning keys are larger than others, but all keys are potentially capable of the same functions if so programmed. Keys should be programmed and used according to their positional convenience.
- Use the included seals to indicate the functions for which learning keys have been programmed. It is recommended that you first determine the best and most convenient layout of the keys for the various functions you plan to program (and attach the seals accordingly), and then program the keys correspondingly.

Follow the steps described below to program signals from other remote-control transmitters to this unit.

1. Set the LEARN-NORM switch to the "LEARN" position.

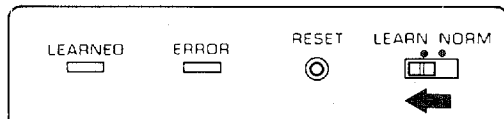

2. Position this unit and the other remote-control transmitter head to head.

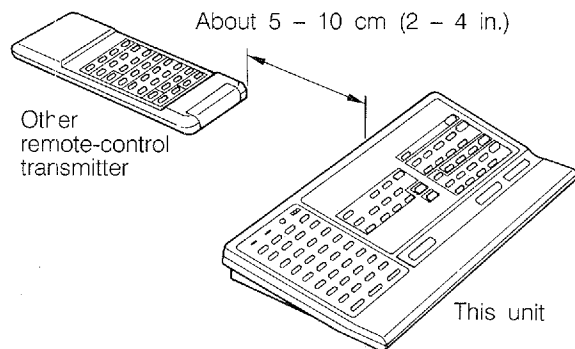

3. Press the learning key (or programmable preset learning key) on this unit to which the programming will be made.

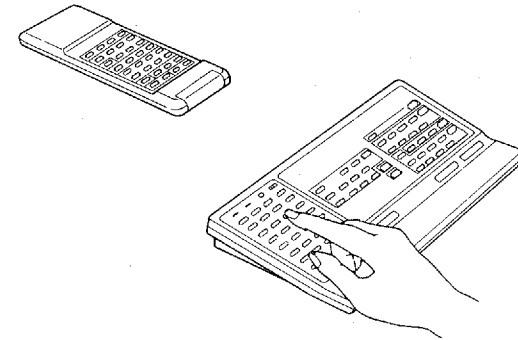

- * If the pressed key is unprogrammed, the LEARNED indicator will flash continuously. If the key is already programmed, the LEARNED indicator will flash continuously and, at the same time, the ERROR indicator will illuminate. Then proceed to the next step if you want to change that instruction already programmed for the key. If you do not want to change it, however, press the key to be programmed next and proceed to the "learning" operation of that key.

4. Press the key (on the other remote-control transmitter) for the function to be programmed.

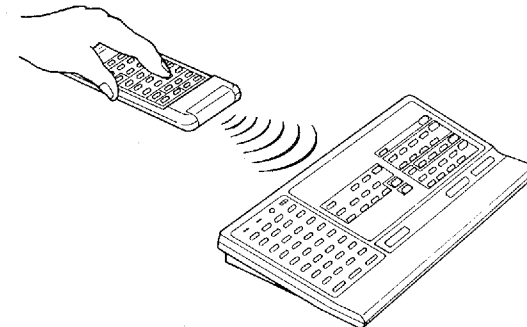

* The LEARNED and ERROR indicators will illuminate continuously while the signals from the other remote-control transmitter are being received by this unit. Press and hold the key on the other remote-control transmitter until the illumination of these indicators stops. The LEARNED indicator will illuminate for about two seconds when the programming of signals has been successfully completed.

5. Repeat steps 3 and 4 until the signals for all programmings you want to make are successfully programmed.
6. After all programming is completed, set the LEARN-NORM switch to the "NORM" position.

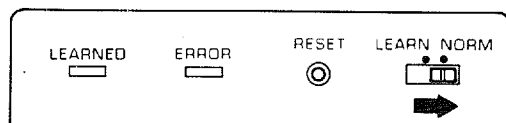

After all programming is completed, try operating this unit.

Notes

- Note that the successful programming of signals to a learning key results in the erasure of previously programmed signals and their replacement by the newly programmed signals.
- In step 4, if the key on the other remote-control transmitter is not pressed within 15 seconds after a learning key is pressed, this unit will automatically return to the status that was in effect before the learning key was pressed.
- If the signals are not successfully programmed to this unit, the ERROR indicator will flash for about two seconds. If signals to be programmed are too long and this unit cannot program them, this unit automatically expands the work area capacity to be doubled, and will then await the next entry. During this stand-by mode the LEARNED indicator flashes rapidly. If this happens, try programming again.

- Although, because this unit employs the variable length programming method, long signals can also be programmed, if all signals programmed are long signals, it might happen that the capacity of the memory area would be completely used before all keys that are programmable are actually programmed, and no further programming would be possible. If this happens, after the signals from the other remote-control transmitter is received (in step 4), the LEARNED indicator and the ERROR indicator will flash two times.

Memory back-up

All of the programmed functions will be retained while you replace the batteries. However, if no batteries are installed for a few hours, the memory will be erased and will have to be programmed again.

Trouble shooting guide

- If programming cannot be made successfully, or if this remote-control transmitter does not function even though the programming was successful, check the following points:
 - * Check whether the batteries of the other remote-control transmitter are weak.

Note that even though its batteries may be strong enough to operate the component it was made for, they may be too weak to transfer signals to this unit. If so, replace the batteries of the other remote-control transmitter.
 - * Check whether the distance between the two remote-control transmitters is too long or too short.
 - * Check whether a strong light, such as direct sunlight, is striking the signal transmitter/receiver of this unit.
- The remote-control transmitter's batteries are too weak if the LEARNED indicator and the ERROR indicator do not illuminate or flash, or if the distance or range within which the remote-control transmitter can be used decreases.

If either occurs, replace the batteries with new ones.
- If, due to a cause other than the above, the indicators do not function during the programming operation, remove the batteries from the unit (in order to reset it) for a few minutes, and then once again insert the batteries.

HOW TO CLEAR SIGNALS PROGRAMMED BY THE LEARNING OPERATION

By using the RESET switch, signals that you have programmed to a learning key or to a programmable preset learning key can be canceled. For a programmable preset learning key, there is a return to the originally preset commands for volume control of the amplifier when this switch is pressed.

1. Set the LEARN-NORM switch to the "LEARN" position.

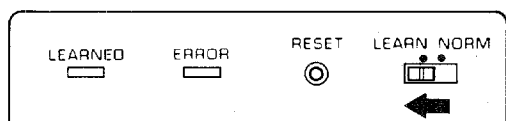

2. Press the RESET switch using the point of a mechanical pencil, etc.. The LEARNED and ERROR indicators will illuminate for 15 seconds.

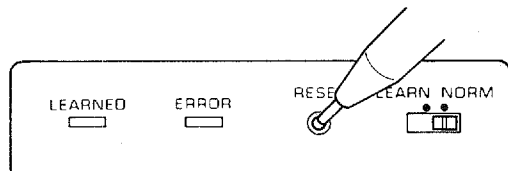

3. Press and then release the learning key (or programmable preset learning key) for which you want the programmed signal to be canceled. The LEARNED indicator's illumination and the ERROR indicator's illumination will then stop. Then, when the cancellation is finished, the LEARNED indicator will illuminate for one second. This indicates the completion of the cancellation process. To cancel two or more programmings, repeat steps 2 and 3.

Note

If a learning key (or a programmable preset learning key) is not pressed within 15 seconds after the RESET switch is pressed, this unit will automatically return to the status that was in effect before the RESET switch was pressed.

REMOTE-CONTROL OPERATION

Note the following points when using this unit for operation of audio/videx equipment.

- Be sure to set the LEARN-NORM switch to the "LEARN" position.
 - If this unit is faced toward the component to be operated and the key pressed correctly so that the correct signal can be transmitted, the LEARNED indicator will illuminate steadily. The ERROR indicator will illuminate if an unprogrammed key is pressed or two or more keys are pressed simultaneously or one after another.
- * If a short signal is transmitted by a learning key, this indicator's illumination will stop when signal transmission ends, even if the key is pressed for a longer time.

TROUBLESHOOTING

Before assuming that your unit is faulty, please check the following troubleshooting list, which details corrective actions you can take yourself without calling a service engineer. If you have any questions, contact your nearest Yamaha dealer.

PROBLEM	POSSIBLE CAUSES	REMEDY
Power is not supplied even though the POWER switch is ON.	The power plug is not securely connected.	Connect it securely.
There is no sound or no picture when any input selector is pressed.	The input wires are not connected securely.	Connect them securely.
	The speaker systems are not connected correctly.	Check and secure the connections.
There is no sound from one speaker.	The speaker connections are not secure.	Secure the connections.
	The BALANCE control is set all the way to the left or right.	Adjust the BALANCE control correctly.
There is a lack of bass, and no ambience.	The + and - wires are connected in reversed at the amplifier or speakers.	Connect the speaker wires in the correct phase (+ and -).
There is a humming sound when playing records.	The input wires are not connected securely.	Connect the input wires securely.
	The turntable's ground wire is not connected.	Connect the ground wire.
There is a howling sound when playing records at high volume.	The turntable and the speakers are too close together, or the turntable is not located on a firm surface.	Change the location of the turntable or the speakers.
The sound suddenly stops.	Using outside the rated impedance range at high power for an extended period has activated the speaker protection circuit.	Switching this unit OFF and then ON will reset the speaker protection circuit. Use speakers within the rated impedance range.
	There is a malfunction in the amplifier.	Consult your Yamaha dealer.

SPECIFICATIONS

Minimum RMS Output Power Per Channel

(20 Hz – 20 kHz 0.1% THD 8Ω/6Ω)	
[U.S.A., Canada and General models]	80W/100W
[Australia, Europe and U.K. models]	48W/60W
Rear (1 kHz 1% THD 8Ω)	
[U.S.A., Canada and General models]	15W
[Australia, Europe and U.K. models]	10W
Center (1 kHz 1% THD 8Ω)	
[U.S.A., Canada and General models]	15W
[Australia, Europe and U.K. models]	10W

Dynamic Power Per Channel

(by IHF Dynamic Headroom Measuring Method)

[U.S.A., Canada and General models]	
8Ω/6Ω/4Ω	115W/145W/175W
[Australia, Europe and U.K. models]	
8Ω/6Ω/4Ω	75W/90W/110W

DIN Standard Output Power Per Channel [Europe model]

1 kHz 1% THD 4Ω	85W
-----------------	-----

Dynamic Headroom [U.S.A., Canada and General models]

8Ω	1.58 dB
6Ω	1.61 dB

IEC Power [Europe model]

1 kHz 0.05% THD 8Ω/6Ω	65W/75W
-----------------------	---------

Damping Factor

1 kHz 8Ω	50
----------	----

Input Sensitivity/Impedance

Phono MM	2.5 mV/47 kΩ
CD/TUNER/TAPE/LD/VCR	150 mV/47 kΩ

Input Sensitivity (New IHF) [U.S.A., Canada and General models]

Phono MM	0.29 mV
CD/TUNER/TAPE/LD/VCR	17 mV

Maximum Input Signal (1 kHz 0.02% THD)

Phono MM	80 mV
----------	-------

Output Level/Impedance

REC OUT	150 mV/1.2 kΩ
---------	---------------

Headphone Jack Rated Output/Impedance

Output Level	0.1% THD RL=8Ω, 240 mV
Impedance	150Ω

Frequency Response

CD/TUNER/TAPE/LD/VCR	20 Hz – 20 kHz, -0.5±0.5 dB
----------------------	-----------------------------

RIAA Equalization Deviation

Phono MM	0±0.5 dB
----------	----------

Total Harmonic Distortion (20 Hz – 20 kHz)

Phono MM to REC OUT, 3V	0.01%
CD/TUNER/TAPE/LD/VCR to Sp Out,	
40W/8Ω [U.S.A., Canada and General models]	0.05%
25W/8Ω [Australia, Europe and U.K. models]	0.05%

Signal-to-Noise Ratio (IHF-A Network)

Phono MM (5 mV Input Shorted)	
[U.S.A., Canada, Australia, U.K. and General models]	79 dB
[Europe model]	76 dB
CD/TUNER/TAPE/LD/VCR (Shorted)	
[U.S.A., Canada and General models]	96 dB
[Australia, Europe and U.K. models]	94 dB

Residual Noise (IHF-A Network) 200 μ V

Channel Separation Vol -30 dB

Phono MC, MM Input shorted

1 kHz/10 kHz 65 dB/50 dB

CD/TUNER/TAPE/LD/VCR Input 5.1 k Ω Terminated

1 kHz/10 kHz 65 dB/50 dB

Tone Control Characteristics

Bass

Boost / Cut ± 10 dB (20 Hz)

Turnover frequency 350 Hz

Treble

Boost / Cut ± 10 dB (20 kHz)

Turnover frequency 3.5 kHz

Mid

Control range ± 10 dB (1 kHz)

Center frequency 1 kHz

Continuous Loudness Control (Level Related Equalization)

Attenuation -20 dB (1 kHz)

Video Input/Output 1 Vp-p/75 Ω

Power Supply

U.S.A. and Canada models AC 120V/60 Hz

Australia and U.K. models AC 240V/50 Hz

Europe model AC 220V/50 Hz

General model AC 110/120/220/240V 60/50 Hz

Power Consumption

U.S.A. model 230

Canada model 380W, 480 V

Australia and U.K. models 400

Europe model 200

General model 400

AC Outlets

[U.S.A., Canada, General and Europe models]

3 SWITCHED OUTLETS 100W max. tot

[Australia and U.K. models]

1 SWITCHED OUTLET 100W max. tot

Dimensions (W x H x D) 435 x 125.5 x 304.7 mm

(17-1/8" x 4-15/16" x 12")

Weight 8.4 kg (18 lbs. 8 oz)

* Specifications are subject to change without notice.

YAMAHA

YAMAHA ELECTRONICS CORPORATION, USA 6722 ORANGETHORPE AVE., BUENA PARK, CALIF. 90620, U.S.A.
YAMAHA CANADA MUSIC LTD. 135 MILNER AVE., SCARBOROUGH, ONTARIO M1S 3R1, CANADA
YAMAHA ELECTRONIK EUROPA G.m.b.H. 2084 RELINGEN, BEI HAMBURG, SIEMENSSTR. 22/34, F.R. OF GERMANY
YAMAHA ELECTRONIQUE FRANCE S.A. 17 RUE DES CAMPANULES, LOGNES 77321 MARNE LA VALLEE CEDEX 2, FRANCE
YAMAHA ELECTRONICS (UK) LTD. YAMAHA HOUSE, 200 RICKMANSWORTH ROAD WATFORD, HERTS WD1 7JS, ENGLAND
YAMAHA SCANDINAVIA A.B. J A WETTERGRENS GATA 1, BOX 30053, 400 43 VÄSTRA FRÖLUNDA, SWEDEN
YAMAHA MUSIC AUSTRALIA PTY, LTD. 17-33 MARKET ST., SOUTH MELBOURNE, 3205 VIC., AUSTRALIA

YAMAHA CORPORATION
10-1 NAKAZAWA-CHO, HAMAMATSU, JAPAN
V164310-0 BWgW, BR   Printed in Japan